

Solavita



SV

7/8/9/10 kW

Single-phase On-grid Inverter

User Manual

Contents

Notes on This Manual	1
1. Important Safety Instructions	2
2. Introduction	4
2.1 Basic Information	4
2.2 Basic Features	4
2.3 Dimensions	4
2.4 Terminals of Inverter	5
2.5 Supported Power Grid	5
3. Installation	6
3.1 Check for Transport Damage	6
3.2 Packing List	6
3.3 Tool preparation	7
3.4 Installation Environment	8
3.5 Installation Space Requirements	9
3.6 Inverter handling	10
3.7 Mounting the Inverter	10
4. Electrical Connections	12
4.1 Grounding Connection	12
4.2 PV Connection	12
4.3 AC Connection	14
4.4 Communication Connection	17
5. Commissioning	23
5.1 Preparation	23
5.2 Inverter Start-Up	23
5.3 Solavita Cloud Download	23
6. Operation method	25
6.1 Control Panel	25
6.2 Menu Structure	26
7. Troubleshooting and Maintenance	30
7.1 Troubleshooting	30
7.2 Maintenance	33
8. Technical Data	34

Notes on This Manual

Scope of Validity

This manual is an integral part of the on-grid inverter. This manual describes the assembly, installation, commissioning, maintenance and troubleshooting of the following model(s) of products:

SV7000TL-S1-CM33 SV8000TL-S1-CM33

SV9000TL-S1-CM33 SV010KTL-S1-CM33

Note: Please keep this manual where it will be accessible at all times.

Target Group

This manual is for qualified electricians. The tasks described in this manual only can be performed by qualified electricians.

Keep the User Manual Properly

This manual serves as an integral part of the device, and you may print out the electronic copy of the user manual on paper as needed, and keep the paper and electronic files in a safe place for subsequent reference. Anyone operating the device at any time must do so in accordance with the requirements of this manual.





Copyright Statement

The copyright of this manual belongs to Jiangsu Skyworth New Energy Technology Co., LTD. Any corporation or individual should not plagiarize, partially or fully copy (including software, etc.), and no reproduction or distribution of it in any form or by any means is permitted. All rights reserved.

This manual may be updated based on user or customer feedback. Please visit our website at www.solavita-ess.com to view the latest version.

Symbols Used







The following types of safety instructions and general information appear in this document as described below:

	<p>Danger! “Danger” refers to a dangerous situation that, if not avoided, will result in a high level of risk such as serious injury or even death.</p>
	<p>Warning! “Warning” indicates a dangerous situation, which, if not avoided, may result in serious injury or death.</p>
	<p>Caution! “Caution” indicates a hazardous situation which, if not avoided, could result in minor or moderate injury.</p>
	<p>Note! “Note” provides tips that are valuable for the optimal operation of our product.</p>









1. Important Safety Instructions

This chapter contains important safety and operating precautions. Read and save this manual for future reference. Before using this device, please read all instructions and warning signs on the device to understand the inverter and all relevant sections of this manual.

The following types of safety instructions and general information appear in this document as described below:

	<p>Danger! Danger to life due to high voltages in the inverter!</p> <p>The personnel responsible for the installation, electrical connection, debugging, maintenance and fault handling operation of this product need to be trained, master the correct operation method, have the corresponding electrician qualification and safety operation knowledge.</p>
	<p>Caution!</p> <p>When the inverter is working, it is strictly forbidden to touch the shell. The temperature of the shell is high and there is a risk of scalding.</p>
	<p>Caution!</p> <p>To reduce the risk of injury, charge only deep cycle lithium iron phosphate rechargeable batteries. Other types of batteries may explode, causing personal injury and damage.</p>
	<p>Warning!</p> <p>Before performing maintenance, cleaning or operation on the circuit connected to the inverter, authorized maintenance personnel must first disconnect the AC and DC power supplies of the inverter.</p>
	<p>Warning!</p> <p>Ensure that the input DC voltage is below the inverter limit. Excessive DC voltage and current may cause permanent damage or other losses to the inverter, which is not covered by the warranty.</p>
	<p>Note!</p> <p>Ground PV system. Finish PV modules and photovoltaic system grounding in accordance with local requirements to achieve optimal protection of systems and personnel.</p>

This section explains the symbols shown on the energy station and on the type label:

	<p>Symbol Explanation CE mark. The energy station complies with the requirements of the applicable CE guidelines.</p>
	<p>Beware of hot surface. The energy station can become hot during operation. Avoid contact during operation.</p>
	<p>Danger of high voltages. Danger to life due to high voltages in the inverter!</p>
	<p>Danger. Risk of electric shock!</p>
	<p>Danger to life due to high voltage. There is residual voltage existing in the inverter after powering off, which needs 5 min to discharge. Wait 5 min before you open the upper lid or the DC lid.</p>
	<p>Observe enclosed documentation.</p>
	<p>The inverter can not be disposed together with the household waste. Disposal information can be found in the enclosed documentation.</p>
	<p>PE conductor terminal.</p>
	<p>Please read the user manual.</p>

2. Introduction

2.1 Basic Information

SV7000-10000-S1-CM33 is a transformerless single phase PV grid-connected inverter. As an integral component in the PV power system, the inverter is designed to convert the direct current power generated from the PV modules into grid-compatible AC current and feeds the AC current to the utility grid.

2.2 Basic Features

This inverter incorporates advanced technology, high reliability and convenient control features.

- Support 150% PV input power
- max. 16A input current to match high power PV modules.
- IP66 outdoor design.
- Up to 98% efficiency, EU efficiency up to 97.5%.
- Safe and reliable: Design with hardware and software protection.
- LCD screen display, friendly human-machine interface.
- AFCI function
- Zero export limitation
- Support 3rd party monitoring system
- Optional DRM function for Australia & New Zealand
- Optional 24-hour loading monitoring

2.3 Dimensions

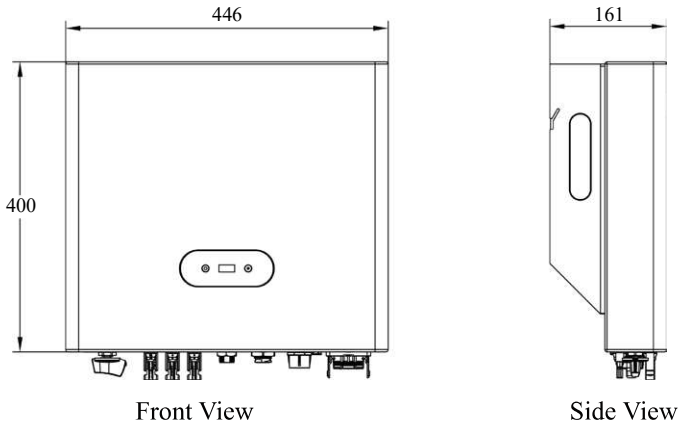

2.4 Terminals of Inverter

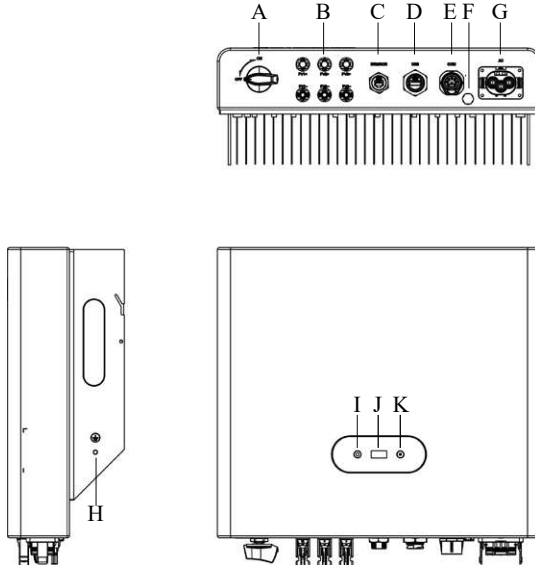

Object	Description	Object	Description
A	DC Switch	G	AC Output Terminal
B	PV Input Terminal	H	Grounding terminal
C	DRM/RCR	I	Indicator Light
D	USB (WiFi/4G optional)	J	LCD
E	COM	K	Button
F	Breathing Valve		

Note: Only authorized personnel can set up a connection.

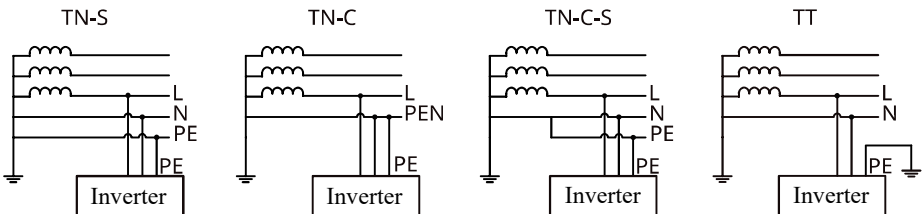

2.5 Supported Power Grid

There are different ways of wiring for different grid systems. Please refer to the figure below:



3. Installation

Note:



	<p>Danger: Do not install SV7000~10000-S1-CM33 on flammable materials. Do not install SV7000~10000-S1-CM33 in a place where flammable or explosive materials are stored.</p>
	<p>The casing and radiator of the inverter become extremely hot during operation. Avoid installing SV7000~10000-S1-CM33 in areas where accidental contact may occur.</p>
	<p>Consider the weight of the inverter when transporting and moving it. Select a suitable mounting location and surface. Equip at least 2 persons to install the inverter.</p>



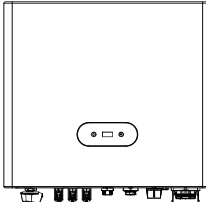
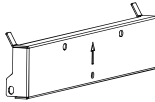
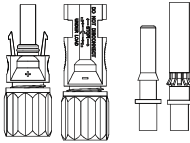
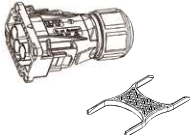
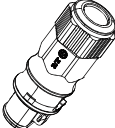

3.1 Check for Transport Damage

Ensure that the inverter is in good condition via transportation. If there is any visible damage such as cracks, please contact the dealer immediately.

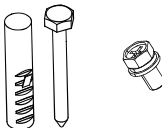
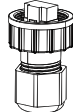



3.2 Packing List



Open the package and take out the product, please check the accessories first. The packing list is shown below. If anything is missing, please contact your local Solavita distributor.

			
<p>Inverter*1</p>	<p>Bracket*1</p>	<p>PV connector(+)*3 PV connector(-)*3</p>	<p>AC connector*1</p>
			
<p>COM connector*1</p>	<p>Data logger*1</p>	<p>Expansion tube*3 Expansion screw*3 Phillips screw*1</p>	<p>RJ45*1</p>

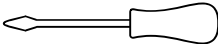
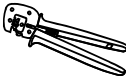
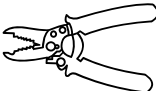
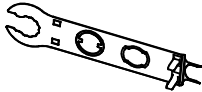
			
<p>Ground terminal*1</p>	<p>Factory Inspection Report</p>	<p>Quick installation Guide</p>	<p>Certificate of conformity</p>

3.3 Tool preparation

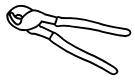
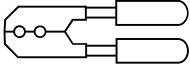
Number	Tool	Description
1		Electric impact drill
2		Spirit level
3		Marker pen
4		Screwdrivers
5		Terminal crimping tool
6		Wire stripper
7		PV disassembly tool
8		Multimeter

9		Hammer drill
10		Wire cutters
11		Network cable pliers
12		Protective equipment

3.4 Installation Environment

1) The inverter operates optimally when the ambient temperature is not higher than 45°C. The inverter is also designed for use in a wide range of applications.

2) The mounting height should preferably be parallel to the line of sight for ease of operation and maintenance.

3) The installation environment of the inverter should be far away from flammable and explosive materials and ensure that there is no strong electromagnetic interference equipment around.

4) The parameter labels and warning signs must be clearly visible after the inverter is installed.

5) When installing the inverter, ensure it is protected from sunlight, rain, and snow during operation.

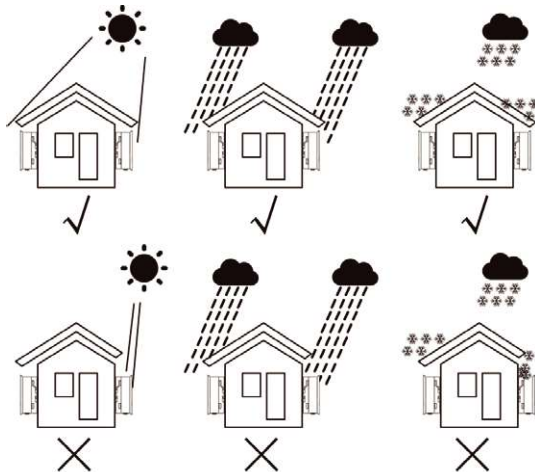

Install the inverter at a maximum back tilt of 15 degrees, the inverter can not be tilted forward, inverted, excessive back tilted or side tilted.

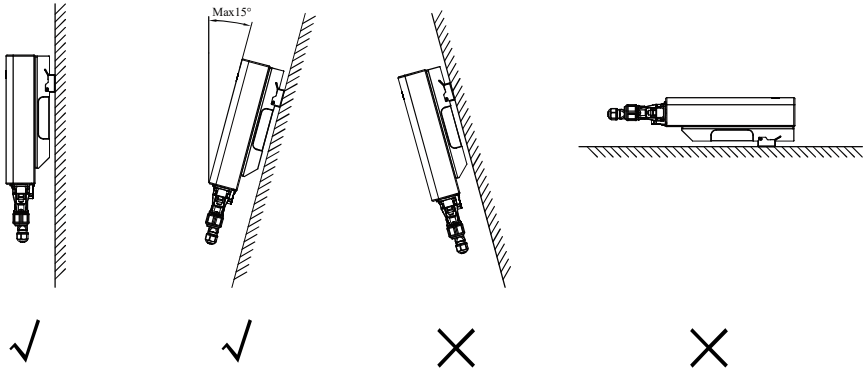

3.5 Installation Space Requirements

	<p>Danger! Always ensure that the inverter cooling system or vents are unobstructed.</p>
---	---

Considering heat dissipation and ease of disassembly, as well as ensuring sufficient space around the inverter for ventilation, the minimum distance around the inverter should not be less than the following values.

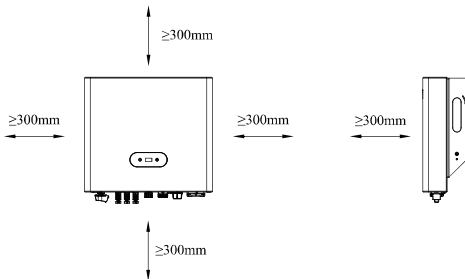

Position	Min Distance
Left	300mm
Right	300mm
Top	300mm
Bottom	300mm

3.6 Inverter handling

	<p>Note:</p> <ul style="list-style-type: none"> •The inverter is heavy, please keep it balanced when moving it to avoid the inverter falling and injuring the operator. •Please place the inverter horizontally; all the terminals at the bottom of the inverter cannot bear weight, so do not let the bottom directly touch the ground. •When placing the inverter on a hard ground, you need to lay protective materials such as foam or paper underneath it.
---	---

Take the inverter out of the outer packaging and carry it horizontally to the designated installation location. Open the outer packaging box, and operators reach under the inverter radiator to carry the inverter out of the outer packaging box and carry it to the designated installation location.

3.7 Mounting the Inverter

3.7.1 Mounting the Inverter with bracket

	<p>In order to avoid electrical shock or other injury, inspect existing electronic or plumbing installations before drilling holes.</p>
---	---

Step 1: Place the bracket at the installation point, use a spirit level to adjust the bracket to a horizontal angle, and mark the drilling positions with a marker pen.

Step 2: Use an electric impact drill to drill holes on the wall. When drilling, keep the electric impact drill perpendicular to the wall and the drilling depth should be slightly greater than the length of the expansion tube.

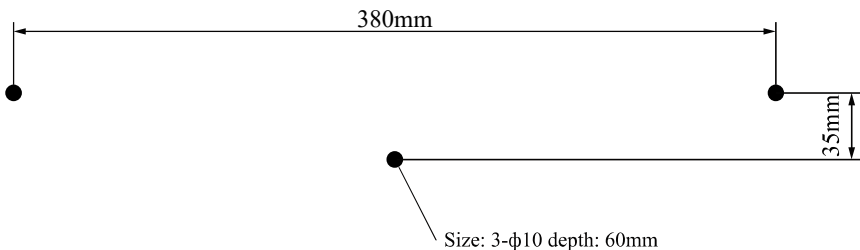

Step 3: Use a hammer to slowly knock the expansion tube into the drilled hole, and fix the bracket with the expansion screws in the accessory bag of the inverter.

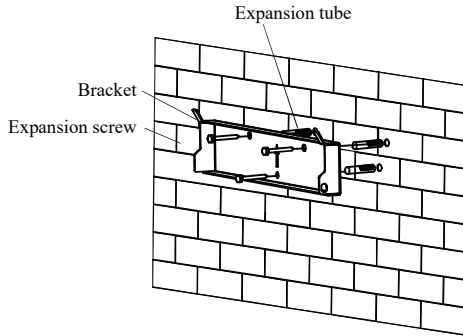

3.7.2 Fixed the inverter on the wall



Falling equipment can cause serious or even fatal injury, never mount the inverter on the bracket unless you are sure that the mounting frame is really firmly mounted on the wall after carefully checking.

Step 1: Rise up the inverter a little higher than the bracket. Considered the weight of them. During the process please maintain the balance of the inverter.

Step 2: Hang the inverter on the bracket through the match hooks on bracket.

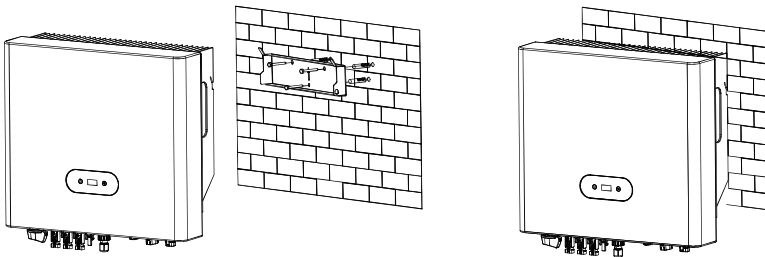

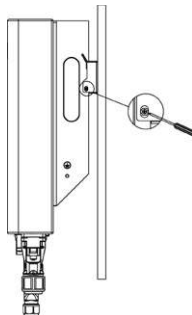

Step 3: After confirming the inverter is fixed reliably, Using M5 Phillips screw in accessory bag to lock the inverter to the bracket.



4. Electrical Connections

4.1 Grounding Connection

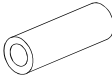
Model	Recommended Cross section (mm ²)
SV7000TL-S1-CM33	4mm ² (10AWG)
SV8000TL-S1-CM33	6mm ² (8AWG)
SV9000TL-S1-CM33	10mm ² (6AWG)
SV010KTL-S1-CM33	10mm ² (6AWG)

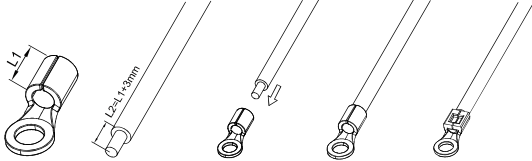
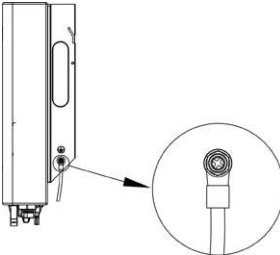
Procedure	
Step 1	<p>Prepare a one-core cable, unscrew the phillips screw on the grounding terminal at the bottom of the inverter, and then find the ground terminal in the accessories.</p> <div style="display: flex; justify-content: space-around; align-items: center;">    </div> <p style="display: flex; justify-content: space-around; align-items: center;"> one-core cable (4 mm²) Phillips screw OT terminal </p>
Step 2	<p>Strip the grounding cable insulation(length L2), insert the stripped cable into the ring terminal, and then clamp it.</p> 
Step 3	<p>Find the ground connection port on the inverter, and screw the ground wire on the inverter.</p> 

4.2 PV Connection

	<p>Note:</p> <ul style="list-style-type: none"> • Before connecting the PV strings, ensure that the DC switch is in the off position. • Ensure that the polarity of the PV strings matches the DC connectors; otherwise, it may damage the inverter. • Ensure that under no circumstances does the maximum open-circuit voltage of the photovoltaic strings exceed the inverter's maximum input voltage of 550V. • Don't connect the positive and negative terminals of the PV strings to the PE line, as it may damage the inverter.
---	--

Recommended DC input cable specifications

Cross section(mm ²)	
Range	Recommended value
4.0-6.0	4.0

Step 1: Turn off the DC switch and prepare the appropriate PV cables. Locate the photovoltaic (+) terminal and photovoltaic (-) terminal, as well as the metal core, in the packaging box.

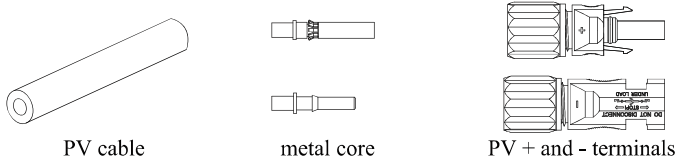

Step 2: Use the wire stripper to strip the wires to a length of 7 ± 0.5 mm, as shown in the diagram below.

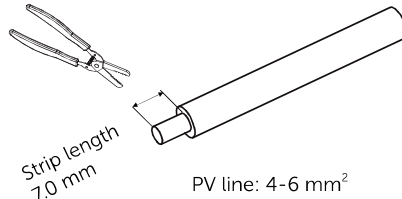

Step 3: Insert the stripped cable into the metal core. Ensure that all wires are fully inserted into the metal core.

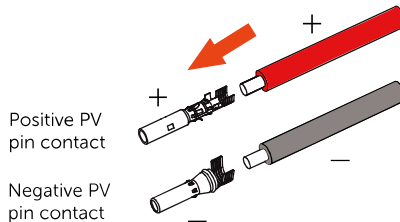

Step 4: Use a MC4 terminal crimping tool to firmly crimp the cable with the PV metal core, ensuring that the cable is securely attached to the metal core.

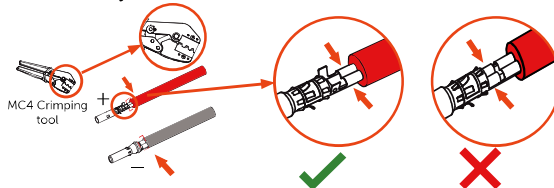

Step 5: Pass the crimped positive and negative cables through the locking nuts and insert them into their respective plastic housings until you hear a 'click' sound, indicating that the metal cores are securely locked into place.

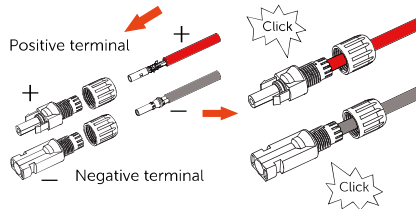

Step 6: Tighten the nuts and use a multimeter to measure the DC input PV voltage to verify the polarity of the DC input cables.

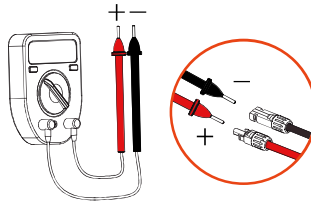

Step 7: Connect the completed DC connector to the inverter as shown in the diagram. A slight "click" sound will confirm that the connection is secure.

4.3 AC Connection

	<p>Note:</p> <ul style="list-style-type: none"> •Each inverter must be equipped with its own dedicated AC circuit breaker; it is prohibited to share a single AC circuit breaker among multiple inverters. •Before making electrical connections, ensure that the inverter DC switch is in the "OFF" position and the AC side circuitbreaker is in the "OFF" position. •Do not connect local loads between the inverter and the AC circuit breaker.
	<p>Note:</p> <p>The inverter has the function of detecting residual current and protecting the inverter against residual current. If an external RCD breaker is mandatory in the country of installation, you must choose a Type A RCD breaker with the rating residual current not less than 300mA.</p>

The recommended specifications for AC cables and AC break are as follows:

Model	Recommended Cross section (mm ²)	AC breaker rating current (A)
SV7000TL-S1-CM33	10	50
SV8000TL-S1-CM33	10	50
SV9000TL-S1-CM33	10	63
SV010KTL-S1-CM33	10	63

Installation procedure:

Step 1: Select the appropriate cable type and specification according to the table; And perform wire stripping treatment on the cables. Please refer to the specific wire stripping length in the diagram.

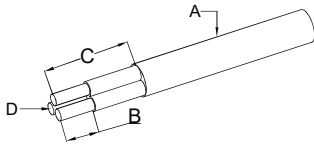

Position	Description	Recommend size
A	Outdoor cable outer diameter range	≤ Ø 22mm
B	Stripping length of insulation layer	7-10mm
C	The stripping length of the outer layer of the cable	50-55mm
D	Outdoor copper core cable (3 cores)	10~16mm ²

Step 2: Insert the main body of the shell into the cable with insulated terminals.

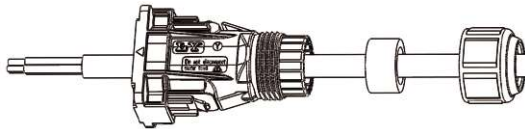

Step 3: Insert the insulated core wires into the corresponding screw holes according to the wiring identification requirements, and tighten the screws. (Recommended tightening torque for M5 screws is 1.5~2.0 N.m)

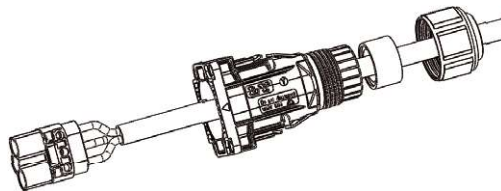

Step 4: Push the housing component into the wiring terminal and hear a clicking sound to confirm that it is assembled properly.

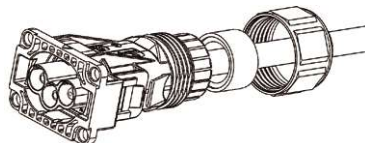

Step 5: Tighten the locking nut with a wrench. (Suggested tightening torque of 2.0~2.5N. m)

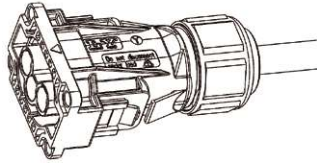

Step 6: Align the AC port slot at the bottom of the inverter and insert this terminal into it.

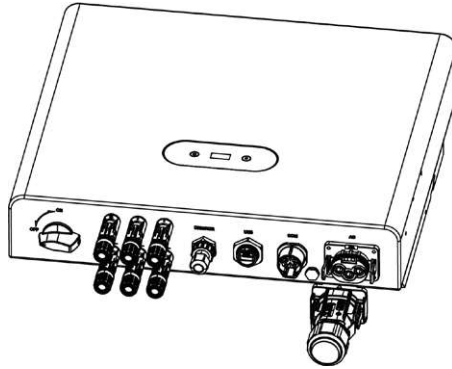

Unlock procedure:

Step 1: Attachment parts on both sides protect the two side catches from being unlocked with hands.

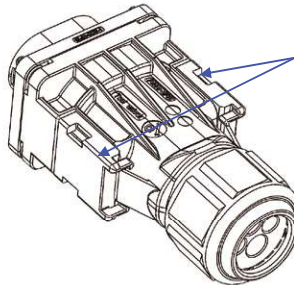

Step 2: Insert the unlocking tool into the side unlocking hole.

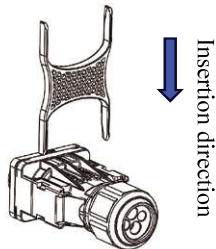

Step 3: Insert the unlocking tool to the bottom, the unlocking tool will top open the carabiners.

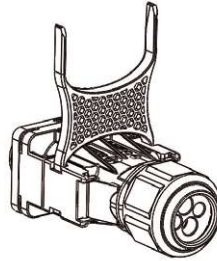

Step 4: Disconnect the cable end by pulling it out along with the unlocking tool.

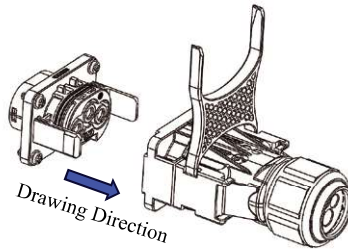

4.4 Communication Connection

4.4.1 APP/WEB Connection

Connect the Data logger to the USB port of the inverter. After the connection is successful, you can view the inverter power generation, operating status and other information through the mobile phone App. For details, please refer to the Data logger user manual.

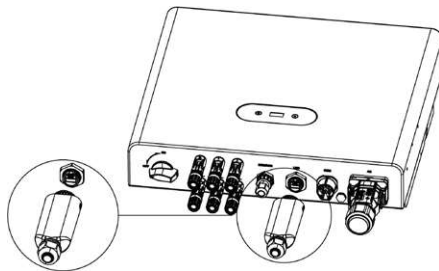

4.4.2 COM Definition

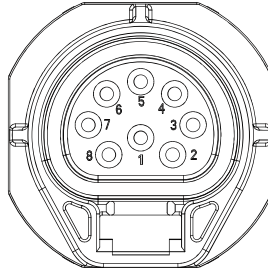

PIN	1	2	3	4	5	6	7	8
Define	CT+	CT-	RS485-	RS485+	DRYOUT_ OPEN-	DRYOUT_ OPEN+	DRYIN	GND_CO M

Zero export limitation

	<p>Note:</p> <ul style="list-style-type: none"> • Inverters are classified as "Meter Model" and "CT Model" due to hardware difference. • Meter Model can only connect a smart meter. • CT Model can only connect a current transformer. • Please consult Solavita Sales Rep before placing the order. • To achieve Export Power Management function, the current transformer must be installed on the grid side.
--	--

① CT connection (Optional) :

The inverter can work with a current transformer to achieve Export Power Management function.

	<p>Note:</p> <ul style="list-style-type: none"> • Do not place the CT on the N Wire or the earth wire. • Do not place the CT on the N and L wire simultaneously. • Do not place the CT with the arrow pointing to the inverter side. • Do not place the CT on the non-insulated wires. • Do not use the wire over 25m.
--	--

Below is the connection diagram of the current transformer.

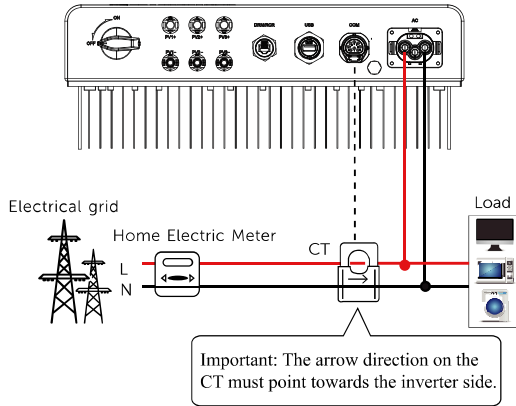

② Meter connection (Optional)

The inverter can work with a single phase smart meter to achieve Export Power Management Function.



Note:

- The smart meter must be purchased from and authorized by us, any third party or non-authorized meter may not match with the inverter. We will not take the responsibility if the meter is unavailable or incompatible in this case.
- The smart meter model we support: Easton SDM120CT

Communication port installation procedure:

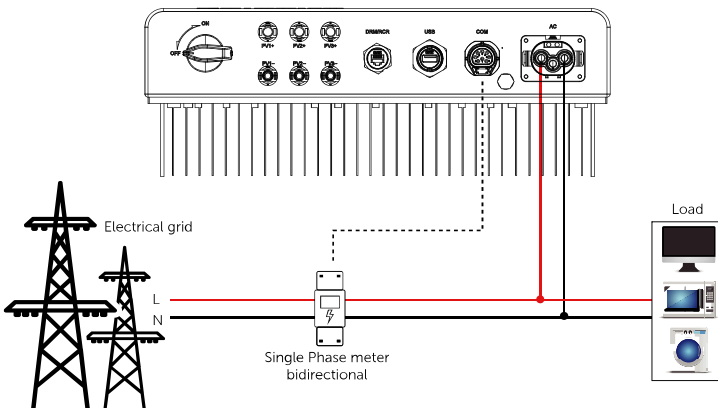

Step 1: Select the appropriate cable type (recommend 20AWG) and specifications; And perform wire stripping treatment on the cables. Please refer to the specific wire stripping length in the diagram.

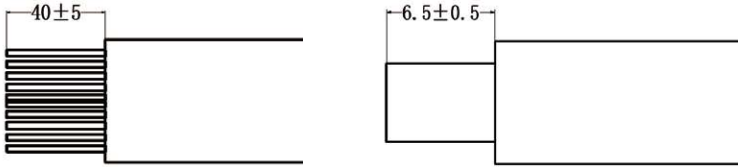

Step 2: Terminal the core wire/immerse it in tin to ensure that the copper wire is not dispersed.

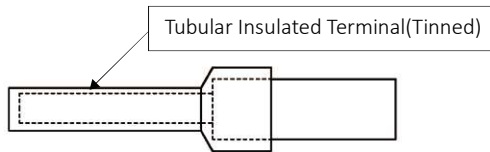

Step 3: Insert the cable into the main component and lock the screw with a Phillips screwdriver. (Recommended tightening torque for screws is 0.1~0.2N. m)

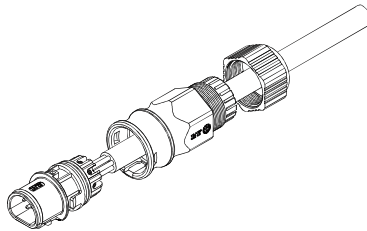

Step 4: Push the main component into the rubber core and assemble it into place when you hear a clicking sound.

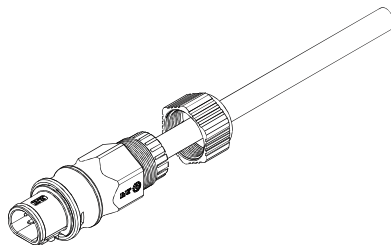

Step 5: Tighten the nut to the main body. (Suggested tightening torque of 3.5 ± 0.5 N.m).

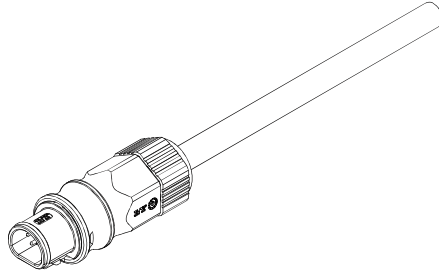

Step 6: Align the COM port slot at the bottom of the inverter and insert this terminal.

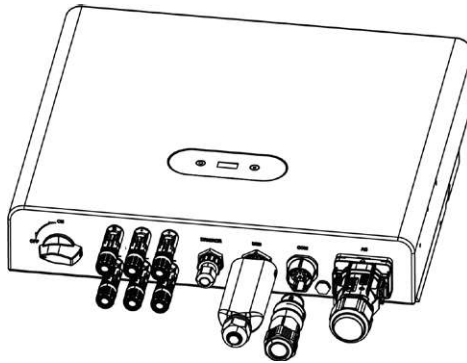

4.4.3 DRM Connection

DRM function (for AS4777) is provided to support several demand response modes by giving control signals as below (For other countries, DRM function is used for remote shut-off) . The user should follow the following PIN rules and cooperate with external equipment when using it.

Mode	Requirement
DRM0	Operate the disconnection device.
DRM1	Do not consume power.
DRM2	Do not consume at more than 50% of rated power.
DRM3	Do not consume at more than 75% of rated power and source reactive power if capable.
DRM4	Increase power consumption (subject to constraints from other active DRMs).
DRM5	Do not generate power.
DRM6	Do not generate at more than 50% of rated power.
DRM7	Do not generate at more than 75% of rated power and sink reactive power if capable.
DRM8	Increase power generation (subject to constraints from other active DRMs).

DRM PIN Definition

The installation steps are the same as BMS connection.

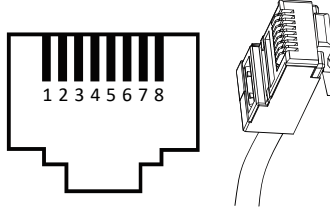

PIN	1	2	3	4	5	6	7	8
Color	Orange/White	Orange	Green/White	Blue	White/ blue	Green	/	/
Define	DRM1/5	DRM2/6	DRM3/7	DRM4/8	REF_GEN/DRM0	COM_LOAD/DRM0	/	/

Installation procedure:

Step 1: Prepare a standard network cable and cable connector, then insert the network cable through the cable connector.



Step 2: Crimp the cable with a RJ45 plug which is inside of the cable connector.

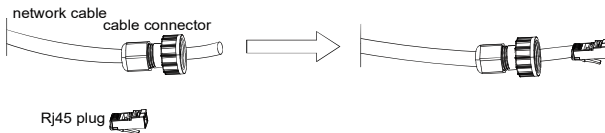

Step 3: Insert the cable connector into BMS port at the bottom of inverter and screw it tightly.

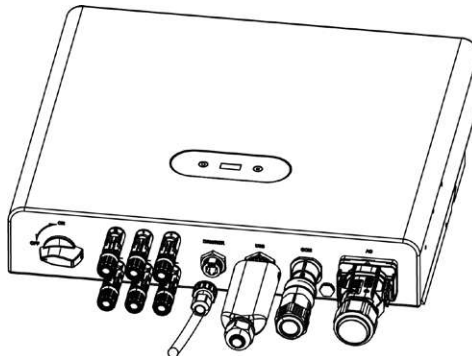

5. Commissioning

5.1 Preparation

Ensure all the devices are accessible for operation, maintenance and service.

- a) Check and confirm that the inverter is firmly installed.
- b) Space for ventilation is sufficient for one inverter or multiple inverters.
- c) Nothing is left on the top of the inverter.
- d) Inverter and accessories are correctly connected.
- e) Cables are routed in safe place or protected against mechanical damage.
- f) Warning signs and labels are suitably affixed and durable.
- g) An Android or IOS mobile phone with Bluetooth function is available.
- h) Measure DC voltage of PV strings and ensure the polarity is correct.
- i) Measure AC voltage and frequency and ensure they are within local standard.

5.2 Inverter Start-Up

If all of the items mentioned above meet the requirements, proceed as follows to start up the inverter for the first time. Strictly follow the preceding sequence. Otherwise, the product may be damaged, and the loss caused is not covered by the warranty.

Step 1: Turn on the AC circuit breaker between the inverter and the grid.

	<p>Note:</p> <p>Before closing the AC circuit breaker between the inverter and the power grid, use a multimeter that is set to the AC gear to ensure that the AC voltage is within the specified range. Otherwise, the inverter may be damaged.</p>
---	--

Step 2: Rotate the DC switch of the inverter to "ON" position.

Step 3: Turn on the external DC switch (if applicable) between the inverter and the PV string.

Step 4: If the irradiation and grid conditions meet requirements, the inverter will operate normally. Observe the LED indicator to ensure that the inverter operates normally. Refer to "6.1 Control Panel" for LED screen introduction and LED indicator definition.

	<p>Note:</p> <ul style="list-style-type: none"> ● If there are other faults with the inverter, please refer to section 7.1 of this manual for troubleshooting ● When the lighting is weak or there is no sunlight, the inverter will automatically stop running and the LED lights of the inverter will turn off. When the lighting is restored, the inverter will automatically restart.
---	--

5.3 Solavita Cloud Download

Users need to download the APP before installing it for the first time.

There are two ways to download and install the latest APP:

1. You can search "Solavita Cloud" in Google Play or App Store.
2. You can scan this QR code below to download "Solavita Cloud".



Android



IOS

6. Operation method

6.1 Control Panel

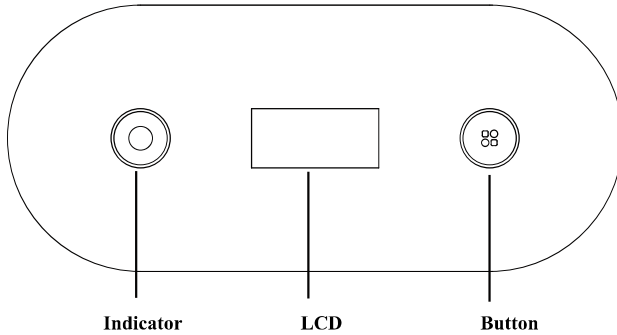

Table 6-1 Display instructions

Name	Description	Display
Indicator	The inverter is in normal status.	Green light always on
	The inverter is in standby status.	Green light flashing
	The inverter is in fault status.	Red light always on
	The inverter is in warning status.	Red light flashing
	The inverter is in firmware update status.	Blue light flashing
LCD	Display the information of the inverter.	/
Button	You can switch the LCD display and set parameter by touching.	/

Table 6-2 Touch button function description

Operation	Function	Description
Click	Page Turn/Value increase	Turn pages,switch options, increase setting values
Double click	Return	Return to previous menu
Long press for 1s	Enter	Select the current menu option or confirm
Long press for 5s	Rapid increase	Set the value to increase rapidly

6.2 Menu Structure

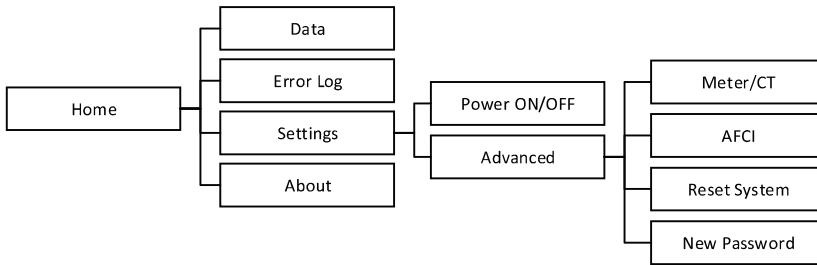

In the Home interface, long press the button to enter the device menu, the menu has the following functions:

- Displaying inverter parameters and detailed operating data
- Setting inverter parameters

6.2.1 Inverter Data

In the Home interface, long press the button to enter the menu, select 'Data' in the options, enter the interface to view the inverter operation data.

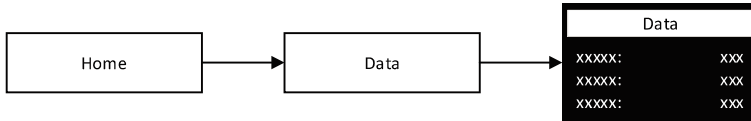

6.2.2 Inverter Error Log

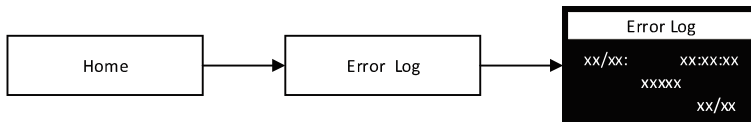

On the Home interface, long press the button to enter the menu, select "Error Log" in the options, and enter the interface to view the inverter's historical error information.

Note: The error code consists of two parts, the error category and the error number. The error category is divided into fault and alarm. The fault is displayed as E and the alarm is displayed as W.

For example, if it displays E1002, E represents the fault and 1002 is the fault code.

6.2.3 Inverter parameter settings

In the Home interface, long press the button to enter the menu, select "Settings" in the options, enter the settings menu, click to switch options in the settings menu, long press to confirm the settings, double-click to return. In the settings, you can set the inverter operating status and advanced settings. Entering the advanced settings requires a password verification. The default password is 1234.

6.2.3.1 Inverter operating status setting

In the "Power ON/OFF" setting option, you can change the inverter operating state and turn the inverter on and off. The operation is as follows:

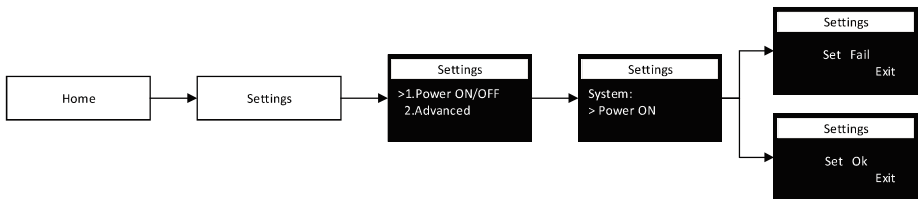

6.2.3.2 Advanced Settings

Advanced settings are password protected and you must enter the password before entering.

① Smart meter/CT and export limitation settings

In this setting, you can choose to use two different configurations: CT or meter. When using the meter, you need to select the meter model and finally set whether to turn on the export limitation function and the export limitation power.

●CT settings:

Select the CT option in the "Meter/CT" setting item, and finally set the zero limitation function as shown below:

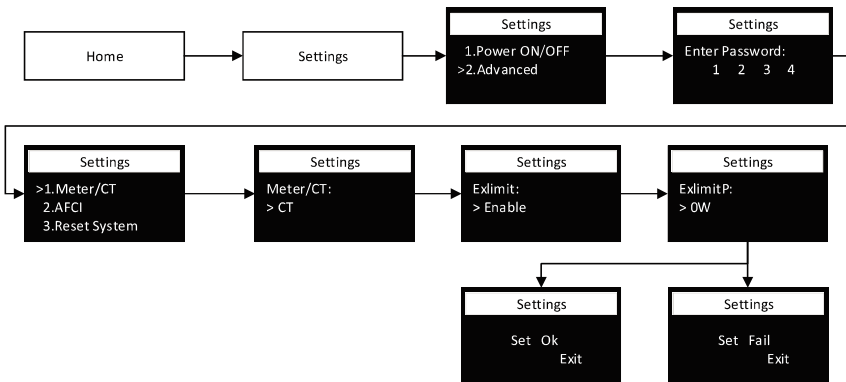

● Smart Meter settings:

Select the "Meter" option in "Meter/CT" and set the corresponding meter model. Finally, set the zero export limitation function as shown below:

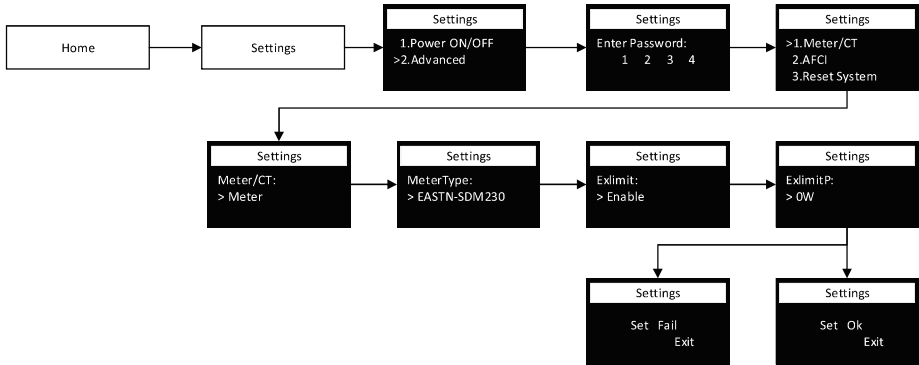

	<p>Note: The smart meter must be purchased from Skyworth, faults with externally purchased smart meters are not covered by the service warranty.</p>
---	---

② AFCI setting

Enable or disable AFCI function settings as follows:

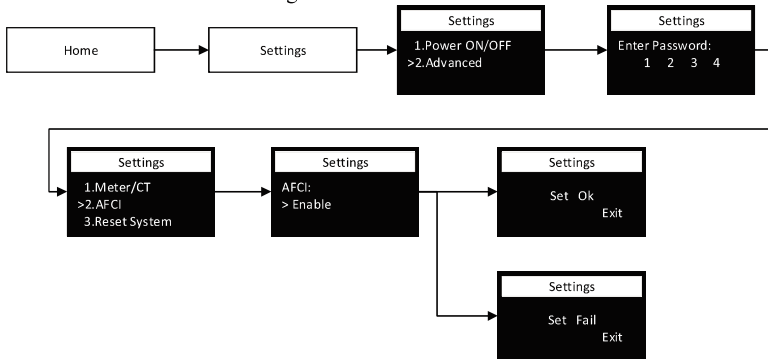

③ System Reset

System reset will clear the inverter setting information and restore the factory default setting parameters. After the setting is successful, the system will restart. The system reset is set as follows:

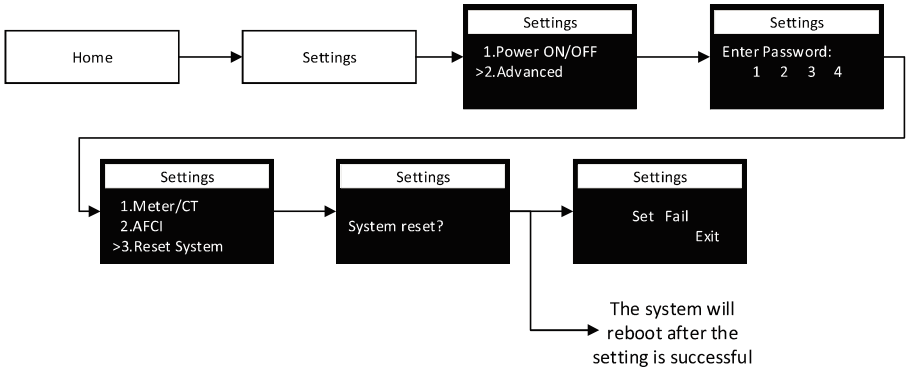

④ New Password Settings

To set a new password for entering advanced settings, follow the steps below:

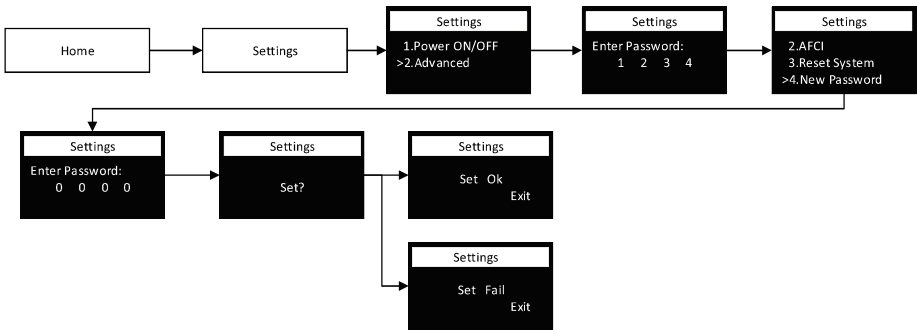

6.2.4 Inverter Information

To view the inverter device information, follow the steps below:

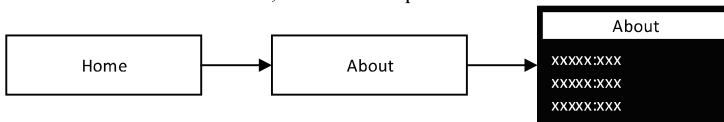

7. Troubleshooting and Maintenance

7.1 Troubleshooting

When the system is in alarm, please log into the Solavita Cloud App to review. The possible causes and their troubleshooting are detailed in the following table:

Fault content	App Display	LCD Display	Handling Suggestions
PV input current hardware measurement overcurrent	PV_OC_HW	E0101	<ol style="list-style-type: none"> 1. Check whether the string is reversed polarity. 2. Restart the inverter. 3. If it has not been eliminated, contact the factory's customer service.
PV input current software measurement overcurrent	PV_OC_SW	E0102	<ol style="list-style-type: none"> 1. Check whether the string is reversed polarity. 2. Restart the inverter. 3. If it has not been eliminated, contact the factory's customer service.
PV string reverse connection fault	PV_REVERSE_CO NNECT_SW	E0103	<ol style="list-style-type: none"> 1. Check if the DC line is reversed. 2. Restart the inverter. 3. If it is still not excluded, please contact the factory customer service.
PV string fault	PV_STRING_SW	E0104	<ol style="list-style-type: none"> 1. Check whether the string is reversed polarity. 2. Restart the inverter. 3. If it has not been eliminated, contact the factory's customer service.
PV input voltage software measurement overvoltage	PV_OV_SW	E0105	<ol style="list-style-type: none"> 1. Check the panel's open-circuit voltage whether the value is similar or already >550Vdc. 2. Please seek help from us when voltage ≤60Vdc.
Output current hardware measurement overcurrent	INV_OC_HW	E0201	<ol style="list-style-type: none"> 1. Verify that the grid is properly connected. 2. Check if the connected power grid is normal. 3. If the mains connection is normal, you need to contact our maintenance staff member.
Output current software measurement overcurrent	INV_OC_SW	E0202	<ol style="list-style-type: none"> 1. Check whether the AC connection is virtual. 2. Restart the inverter. 3. If it has not been eliminated, contact the factory's customer service
Grid frequency is too low	GRID_OF_SW	E0203	<ol style="list-style-type: none"> 1. Wait for one minute, grid may go back to normal working state. 2. Make sure that grid voltage and frequency complies with standards. 3. Or please seek for help from us.
Grid frequency is too high	GRID_UF_SW	E0204	<ol style="list-style-type: none"> 1. Wait for one minute, grid may go back to normal working state. 2. Make sure that grid voltage and frequency complies with standards. 3. Or please seek for help from us.
Grid loss	GRID_ZERO_CROS S_LOSS_SW	E0205	<ol style="list-style-type: none"> 1. Please check grid-connection, e.g., wires, interface etc. 2. Checking grid usability. 3. Or seek for help from us.

Ten-minute voltage average overvoltage	GRID_10MIN_OV	E0206	1.System will reconnect if the grid is back to normal. 2.Or seek for help from us if it does not go back to normal state..
Relay failure	RLY_FAULT	E0207	1.Disconnect PV (+), PV (-) with DC. 2.After the LCD switches off, reconnect and check again. 3.Please seek for help from us if it does not go back to normal state.
Grid voltage is too high	GRID_OV_SW	E0208	1.Wait for one minute, grid may go back to normal working state. 2.Make sure that grid voltage and frequency complies with standards. 3.Or, please seek for help from us.
Grid voltage is too low	GRID_UV_SW	E0209	1.Wait for one minute, grid may go back to normal working state. 2.Make sure that grid voltage and frequency complies with standards. 3.Or, please seek for help from us.
DC bus voltage hardware measurement is too high	BUS_OV_HW	E0401	1.Disconnect PV (+), PV (-) with DC. 2.After the LCD switches off, reconnect and check again. 3.Please seek for help from us if it does not go back to normal state.
The DC bus voltage software measurement is too high	BUS_OV_SW	E0404	1.Disconnect PV (+), PV (-) with DC. 2.After the LCD switches off, reconnect and check again. 3.Please seek for help from us if it does not go back to normal state.
The DC bus voltage software measurement is too low	BUS_UV_SW	E0405	1.Disconnect PV (+), PV (-) with DC. 2.After the LCD switches off, reconnect and check again. 3.Please seek for help from us if it does not go back to normal state.
The DC bus voltage changes too fast	BUS_VOLT_OVER_SHOOT_SW	E0406	1.Disconnect PV (+), PV (-) with DC. 2.After the LCD switches off, reconnect and check again. 3.Please seek for help from us if it does not go back to normal state.
L line ground fault	LINE_CONNECT_T O_PE	E0407	1.Set the inverter to run stop operation. 2.Reset the inverter run again and check whether the fault is occurred. 3. If the alarm continues, please contact us for assistance.
CT_fault	CT_FAULT	E0408	1.Check whether the sequence of CT1+&CT1- or CT2+&CT2- is correct ,and ensure a correct sequence and connection. 2. If the alarm continues, please contact us for assistance.
Island fault	ISLANDING	E0409	1.Wait for the grid to restore power. 2.If the alarm continues, please contact us for assistance.
DCI Fault	DC Injection High	E0410	1.Wait for one minute after the inverter reconnects to grid. 2. Disconnect PV (+), PV (-) with DC. 3. After the LCD switches off, reconnect and check again. 4. Please seek for help from us if it does not go back to normal state.
Insulation resistance test fault	ISO	E0411	1.Turn off inverter and turn the DC switch off. 2.Measure the resistance between PV input and PE. If the resistance is less than 30K ohm,Please contact us for assistance. If not, turn on DC Switch and turn on inverter again and check whether the fault is happen. 3. If the alarm continues, please contact us for assistance.

Inverter overheating	Over temperature in inverter	E0412	1.Check if the environment temperature is over the limit. 2.Or seek for help from us.
GFCI protection error: 30 mA rating	GFCI protect fault:30mA level	E0413	1.Disconnect DC and AC connector, check the surrounding equipment on the AC side. 2.Reconnect the input connector and check the state of inverter after troubleshooting. 3.Please seek for help from us if it does not go back to normal state.
GFCI protection error: 60 mA rating	GFCI protect fault:60mA level	E0414	1.Disconnect DC and AC connector, check the surrounding equipment on the AC side. 2.Reconnect the input connector and check the state of inverter after troubleshooting. 3.Please seek for help from us if it does not go back to normal state.
GFCI protection error: 150 mA rating	GFCI protect fault:150mA level	E0415	1.Disconnect DC and AC connector, check the surrounding equipment on the AC side. 2.Reconnect the input connector and check the state of inverter after troubleshooting. 3.Please seek for help from us if it does not go back to normal state.
Wrong ground connection	GROUND FAULT	E0501	1.Check the voltage of neutral and PE. 2.Check AC wiring. 3.Restart inverter, if error message persists, seek for help from us.
Auxiliary ARM communication lost	ARM_COM_MISS	E0502	1.Disconnect PV (+), PV (-) with DC. 2.After the LCD switches off, reconnect and check again. 3.Please seek for help from us if it cannot go back to normal state.
Leakage current overcurrent	RCD OCP	E0903	1. Connect each string component individually to determine if it is caused by a component problem. If there is no error when inserting one of the string components, it can be determined that it is a string problem. Check whether the string in question is broken or not. 2. If this error is only caused by a rainy day or a certain time of the morning, it is because the aging of the module causes the leakage current to be too large. When the weather is fine or the air humidity is reduced, the error will be cleared automatically. Can be resolved through remote upgrade software.
Communication failure with DSP	DSP Comm ERR	E0904	1.Disconnect PV (+), PV (-) with DC. 2.After the LCD switches off, reconnect and check again. 3.Please seek for help from us if it cannot go back to normal state.
Insulation detection fault	ISO ERR	E0905	1.Check the impedance among PV (+), PV (-) and ground. Impedance should be >1Mohm. 2. Please seek for help from us if it cannot be detected or the impedance is <1Mohm.
GFCI module failure	GFCI ERR	E0907	1.Disconnect DC and AC connector, check the surrounding equipment on the AC side. 2.Reconnect the input connector and check the state of inverter after troubleshooting. 3.Please seek for help from us if it does not go back to normal state.

AFCI module failure	AFCI ERR	E0908	1.Restart the inverter. 2.If it is still not resolved, contact the factory's customer service.
Meter communication lost	MTR Comm Lost	E1002	1.Check the meter communication and restart the inverter. 2.If it is still not resolved, contact the factory's customer service.

7.2 Maintenance

	<ul style="list-style-type: none"> ● Incorrect maintenance may cause damage to the inverter or personal injury! ● Always remember that the inverter photovoltaic string and the grid provide bidirectional power supply. Before carrying out any maintenance work, please follow the following steps: <ol style="list-style-type: none"> ① Disconnect the AC circuit breaker and then turn off the DC circuit breaker switch of the inverter. ② Wait for at least 5 minutes to fully discharge the internal capacitor. ③ Confirm that there is no voltage or current before unplugging any connectors.
	<p>Note!</p> <p>Only after eliminating faults that affect safety performance can the inverter be restarted. Due to the lack of maintenance spare parts in the inverter packaging, do not replace any internal components at will. If you have any maintenance needs, please contact our company. Otherwise, our company shall not be responsible for any damages caused.</p>

Item	Method	Period
Device clean	Check the temperature and dust of the inverter. Clean the inverter enclosure if necessary.	Six months to a year (depending on the dust contents in air)
Electrical connection	Check whether all cable are firmly connected in place. Check whether there is damage to the cables, especially the surface in contact with metal.	6 months after commissioning and then once or twice a year
General status of the system	<ul style="list-style-type: none"> • Visual check for any damage or deformation of the inverter. General status of the system • Check any abnormal noise during the operation. • Check each operation parameter. • Be sure that nothing covers the heat sink of the inverter. 	Every 6 months

8. Technical Data

Model	SV7000TL-S1 -CM33	SV8000TL-S1 -CM33	SV9000TL-S1 -CM33	SV010KTL-S1 -CM33
PV Input				
Recommended Max. PV Input Power [Wp]	10500	12000	13500	15000
Max. Voltage [V]	550*			
MPPT Voltage Range [V]	60-520*			
Rated Voltage [V]	360			
Start-up Voltage [V]	70			
No. of MPPT Trackers	3	3	3	3
No. of PV Strings per MPPT	1/1/1	1/1/1	1/1/1	1/1/1
Max. DC Current [A]	16/16/16	16/16/16	16/16/16	16/16/16
Max. Short Circuit Current[A]	20/20/20	20/20/20	20/20/20	20/20/20
Max. Inverter back feed current to the array [mA]	0			
AC Output				
Nominal AC Active Power [W]	7000	8000	9000	10000
Max AC Current [A]	31.8	36.4	40.9	45.5
Max. Output Current [A]	31.8	36.4	40.9	45.5
Max AC Apparent Power [VA]	7000	8000	9000	10000
Nominal Grid Voltage [V]	220/230/240			
Nominal Grid Frequency [Hz]	50/60			
Power Factor Range [φ]	1(0.8leading- 0.8lagging)			
Current (inrush)	<10@5 ms (peak and duration)			
THDi (Rated Output Power)	<3%			
Efficiency				
Max. Efficiency	98.0%			
Euro Efficiency	97.5%			
Protection				
DC Switch	Integrated			
Insulation Resistance Detection	Integrated			
Input Reverse Polarity Protection	Integrated			
Anti-island Protection	Integrated			
Residual Current Monitoring	Integrated			
AC Overcurrent Protection	Integrated			
AC Short-circuit Protection	Integrated			
DC Surge Protection	Integrated (Type II)			
AC Surge Protection	Integrated (Type II)			
IV Curve scanning	Integrated			
24-hour load monitoring	Optional			
DC Arc Protection	Optional			
General Data				
Dimensions (W*H*D) [mm]	446*400*161mm			
Weight [kg]	17kg			

Display	LED+LCD/ Bluetooth+App
Protective class	I
OverVoltage category	III(AC side),II(PV side)
Communication	RS485/WiFi/LAN/4G (Optional)
Operation Ambient Temperature Range [°C]	-30 ~ +60
Relative Humidity	0 ~ 100%
Operation Altitude[m]	≤4000(if > 3000, derating)
Ingress Topology	non-isolated
Cooling Concept	Natural Convection
Ingress Protection	IP66

* The max. input voltage is the upper limit of the inverter's DC voltage, and any higher max. DC input voltage may damage the inverter.

* Any PV input voltage exceeding the MPPT voltage range of the inverter may cause abnormal operation of the inverter.

Note: The above values are measured by Skyworth's internal laboratory under specific conditions. Actual values may vary due to product, software version, usage conditions, and environmental factors.

Solavita

Lead The Way to Green Life



Scan for More Information

✉ sales@solavita-ess.com

🌐 www.solavita-ess.com

☎ +86 051265293687

📍 NO. 599, TAISHAN ROAD, SUZHOU, JIANGSU, CHINA